

Verifying the Calibration of Optical Particle Counters below 100nm

by
David Blackford PhD (Fluid Measurement Technologies, Inc.)
and
Gary Van Schooneveld and Don Grant (CT Associates, Inc.)

Introduction

Optical Particle Counters (OPCs) are critical for monitoring particle contamination in the Ultrapure Water (UPW) used to manufacture semiconductors. However, OPCs from different manufacturers rarely correlate with each other because the manufacturers use different wavelengths, different angles of collection, and different definitions of illuminated area from each other.

Currently, all OPCs are calibrated using Polystyrene Latex (PSL) spheres. An OPC's response to real particles in UPW is therefore based on how an OPC measures light scattered from white, plastic spheres suspended in UPW. PSL spheres are an unrealistic, but convenient calibration material for OPC calibration. An alternative name for OPCs could be "scattered-light event monitors," as OPCs measure an equivalent particle size based on a PSL calibration.

PSL spheres have been available with National Institute of Standards and Technology (NIST) and Advanced Industrial Science Technology (AIST) **size** certification for many years. JSR Corporation of Japan has produced concentration standards (**size and number** per mL) for PSL sizes greater than 170nm. But PSL size and number standards smaller than 100nm have been very difficult to produce. Therefore, the manufactures of 50 nm OPCs (including PMS, Rion, Lighthouse, Hach, and Horiba) must rely on an internal "gold standard" OPC to calibrate their production OPCs for number concentration. Consequently, when OPCs from different manufacturers are run side-by-side on the same Ultrapure water system, they can report significant (up to 100%) differences in number concentration (1).

The minimum detected particle size is a frequently misunderstood OPC parameter. A 50nm OPC only has a detected efficiency of a few percent at 50nm, regardless of the OPC manufacturer.

In order to improve the usefulness of OPCs for monitoring the quality of UPW, the authors have developed a series of PSL verification standards (size and number per mL). Sizes at 60nm, 70nm, 80nm, 100nm, and 120nm are currently available. The new standards can be used to "validate or verify" the current calibration of an OPC.

One problem of "ready to use" standards for sizes smaller than 100nm is the ease with which these standards are contaminated by particles released from the bottle that contains them. The authors' innovative method for avoiding contamination from the bottles is to carefully adjust concentrations to 4×10^7 PSL spheres per mL, in small, single-use bottles. The final concentration can be adjusted using a precision dilution system.

The authors' new verification size and number standards can't correct for the fundamental deficiencies of detecting particles using scattered light, but the new verification standards should verify the counting accuracy of OPCs below 100nm.

Particle Standard Concentration Verification

Particle concentrations in the authors' new PSL standards are verified using an UltraFine Atomization and Scanning Mobility Particle Sizer (UFA/SMPS). First, the UFA/SMPS is calibrated for the volume of liquid atomized by the nebulizer. Then, particle size distributions (PSDs) in a hydrosol (in this case, a PSL suspension in UPW) are measured by atomizing the hydrosol using a nebulizer, drying the resulting aerosol, and measuring the size distribution of the aerosol particles using SMPS (see Figure 1). The SMPS is a technique for measuring aerosol PSDs that has been thoroughly characterized.

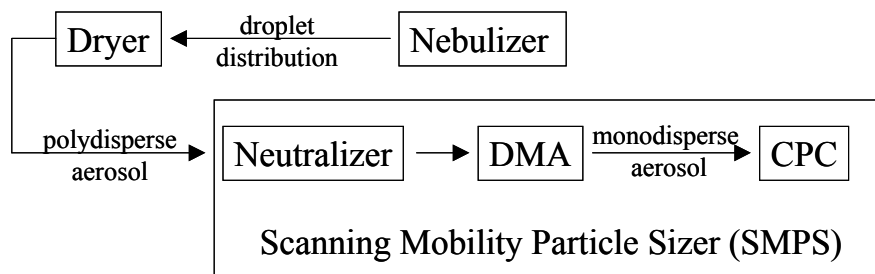

Figure 1: UFA/SMPS Simplified Schematic

UFA/SMPS Calibration

An accurate measurement of the PSD requires the following:

- Droplets exiting the nebulizer contain no more than one particle per droplet.
- The amount of non-volatile dissolved material in each droplet is insufficient to form a particle large enough to interfere with the analysis when the liquid in the droplet is evaporated.
- A known volume of liquid is atomized by the nebulizer (necessary to quantitatively determine the particle concentration, rather than the relative concentrations of each particle size).

A proprietary colloidal dispersion is used to perform the UFA/SMPS calibration. The dispersion contains a very low concentration of non-volatile dissolved material. The mass concentration of particles in the dispersion is well known and is verified by evaporating the liquid from a known volume of the dispersion to dryness and then measuring the mass of the residue. The dispersion is then diluted with precision, the diluted suspension is atomized, and the volume-weighted size distribution of the particles in the resulting aerosol is measured.

An example showing differential PSD measurements of 8 different diluted standards is shown in Figure 2. The mass of the particles in the aerosol is determined by integrating the distributions shown in Figure 2 with respect to particle diameter and multiplying the result by the particle density. Once the mass concentrations of particles in the dispersion and the aerosol are precisely known, the volume of liquid atomized is accurately calculated.

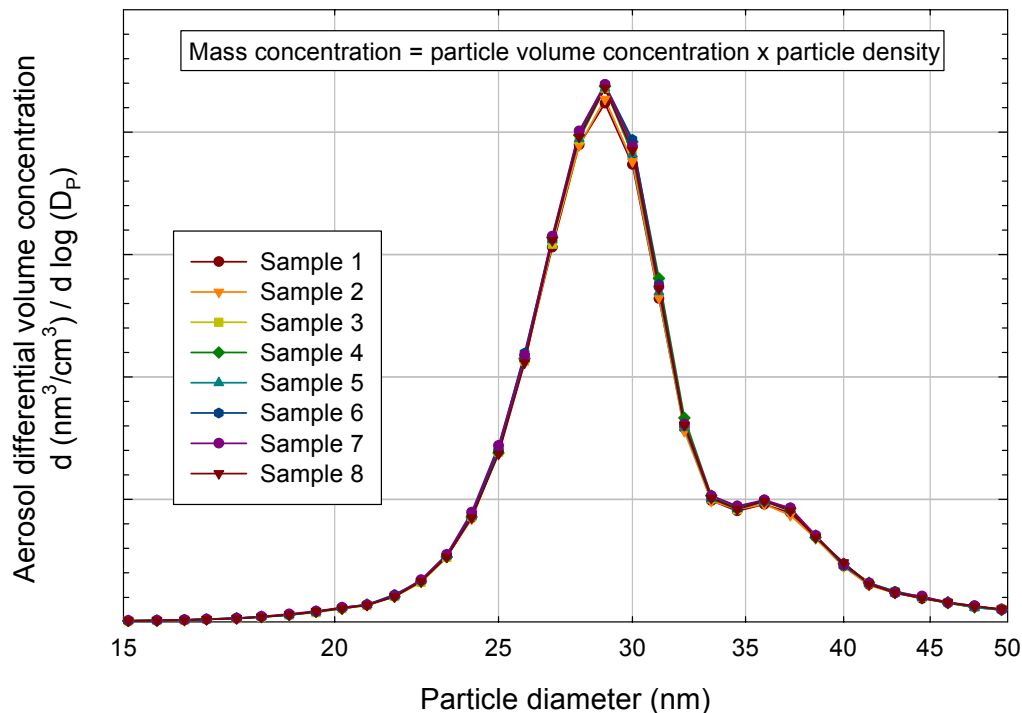

Figure 2: A typical UFA/SMPS measurement of a colloidal dispersion, from which the mass concentration can be calculated

Figure 2 displays optimal measurement conditions because there is no residue interference and no particle/droplet coincidence (where multiple particles are found in individual droplets). An instrument must be well characterized to ensure that these conditions are met. There is no rapidly decreasing small-particle tail in figure 2, indicating that there is no dissolved residue interference in the sample. In Figure 3, number-weighted PSDs were measured using a calibration standard that had been intentionally spiked with high concentrations of dissolved non-volatile residue. Consequently, examples of residue tails can be seen on the graph.

Diluting the hydrosol sample to yield a concentration at the atomizer between 10^9 and 10^{11} particles/mL ensures the absence of particle-droplet coincidence. Figure 4 shows examples of calibration-standard, number-weighted PSDs measured at concentrations below 10^9 particles/mL (Graph A), in the range of 10^9 and 10^{11} particles/mL (Graph B), and above 10^{11} particles/mL (Graph C). Graph A shows that, at low concentrations, the measurement is “noisy” due to poor counting statistics. Graph C shows the presence of a large particle tail caused by particle/droplet coincidence. Graph B shows that identical PSDs are obtained in the optimal range.

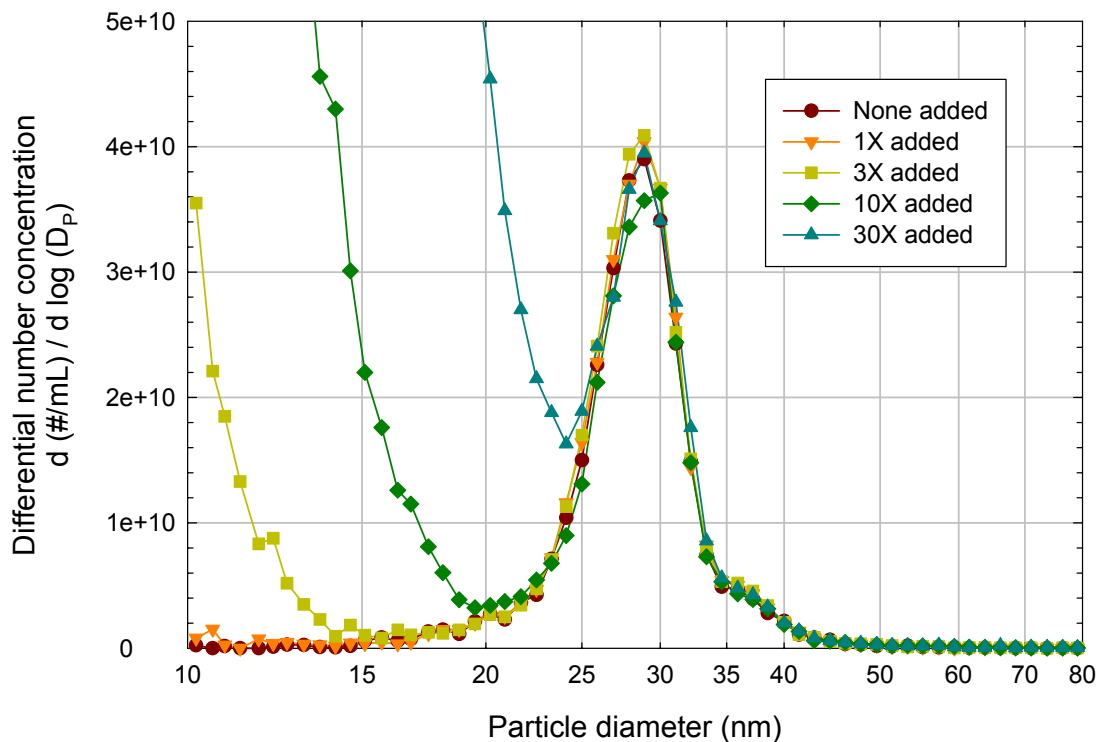

Figure 3: Measured PSDs in mass standards “spiked” with high concentrations of dissolved non-volatile residue

PSL Concentration Measurement

When the UFA/SMPS has been calibrated (as described above), the concentration in the bottle of commercially-available, NIST-traceable PSL size standards is accurately determined by the following process.

1. The PSL standards are diluted by a carefully controlled ratio to yield a concentration of approximately 10^{10} particle/mL.
2. The actual concentration of the dilution is measured using the UFA/SMPS.
3. The concentration of particles in the purchased size standard is determined by multiplying the measured concentration by the dilution ratio. Figure 5 shows examples of normalized PSDs of commercially-available 50nm, 60nm, and 100nm PSL size standards (nominal sizes) measured using UFA/SMPS.

When the concentrations of the PSL size standards have been measured, the final concentration standards are prepared by accurate dilution. The dilution is carried out following these steps:

1. The PSL are diluted to a concentration of 1.0×10^{12} /mL.
2. The concentration is verified using the UFA/SMPS (as described above).
3. The second dilution yields the final concentration of 4.0×10^7 /mL.

A. PSDs measured at lower concentrations

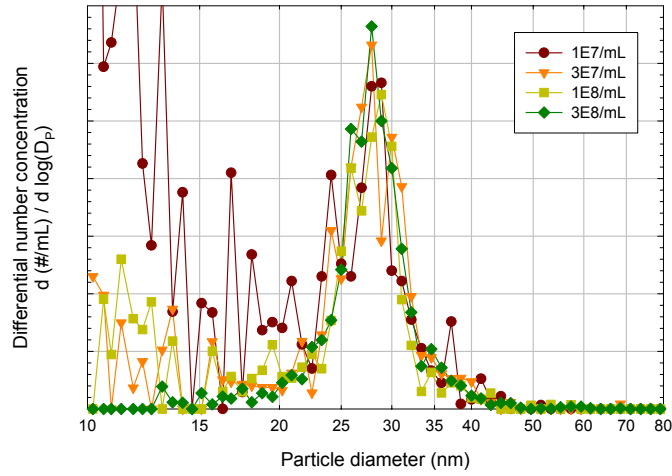

B. PSDs measured at "optimum" concentrations

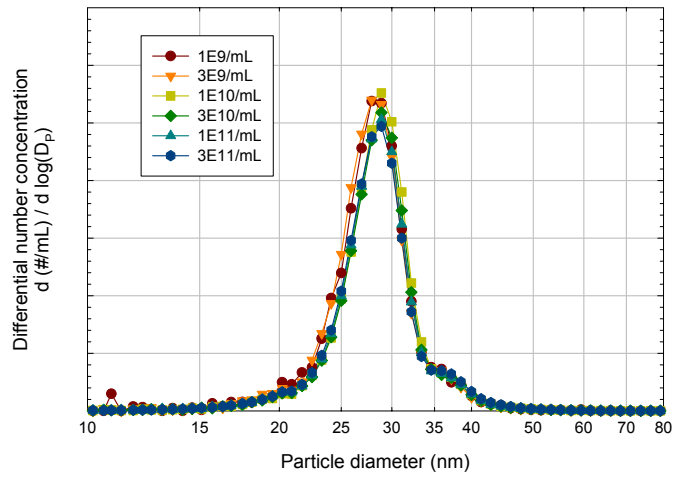

C. PSDs measured at high concentrations

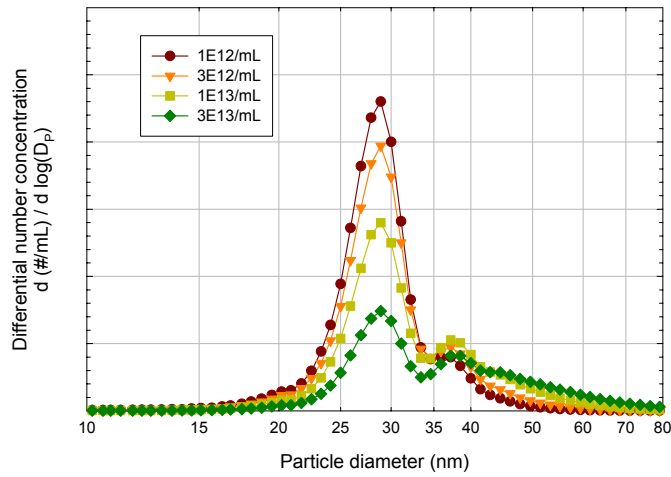

Figure 4: Mass standard PSDs measured at selected particle concentrations

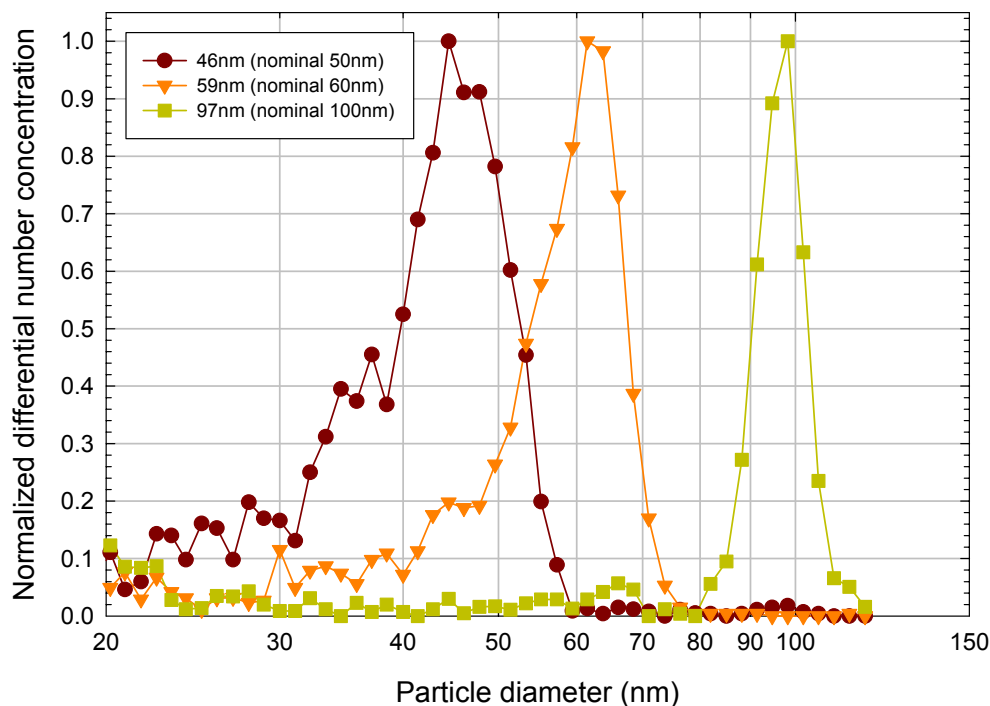

Figure 5: Examples of commercially-available PSL particle size distributions

Particle contribution from the sample bottles

One of the challenges in providing a particle-count standard, particularly for standards smaller than 100 nm, is the contamination of particles from the sample bottle. The authors discovered that particle concentration increases with bottle handling. They therefore developed a testing method to identify the best bottle to use for shipping the standards. Most high-quality, sample bottles contribute a relatively low level of particles during the fill procedure. However, when the sample bottle is gently inverted, considerable shedding of particles can occur and the level of shedding can be large enough to invalidate the standard.

Figure 6 shows the effect of particle shedding caused by gentle bottle inversion. A 60 mL polypropylene bottle was filled approximately half full with UPW. The bottle was then connected to the PSL Dilution System (see description below) and the bottle contents measured using the same dilution protocol used for a calibration standard (the dilution ratio was set for 2,500:1). The particle concentration was measured using multiple Particle Measuring System M50 optical particle counters. After measuring the particle concentration immediately after filling, the bottle was removed, capped, and gently inverted 200 times. The contents of the bottle were measured a second time (“200 inverts”). The test was repeated a third time after inverting an additional 300 times (“500 inverts”). Figure 6 shows that there was a significant addition of particles in the sample bottle after each inversion test. Factoring in the 2,500:1 dilution ratio, each inversion adds nearly 6,000 particles per mL >50nm. Additional testing demonstrated that the authors were counting measuring actual particles and not bubbles resulting from the inversions. Figure 7 illustrates that other bottle types and materials demonstrated a similar shedding behavior.

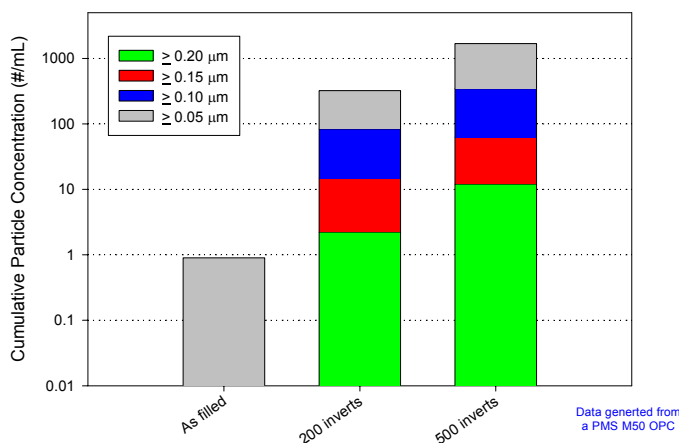

Figure 6: Particle concentration change caused by gentle bottle inversion

Chemical and hot UPW cleaning methods were ineffective in reducing the particle shedding to the background levels required.

In previous studies performed on high-purity packaging (2) a similar shedding phenomenon was observed. The shedding of particles from a surface appears to increase with the movement of a gas/liquid/solid interface. Particle shedding can therefore be lowered by reducing, or eliminating, the gas/solid/liquid interface. Reducing the headspace in standards bottles effectively reduces the interface and therefore limits particle shedding. Figure 8 shows the effect on particle shedding of filling bottles nearly full and then inverting them 200 times.

Based on their bottle-testing data, the authors determined that the best size for the standard bottles is 4mL and 8mL, and the bottles should be filled to provide minimal headspace for any air pocket.

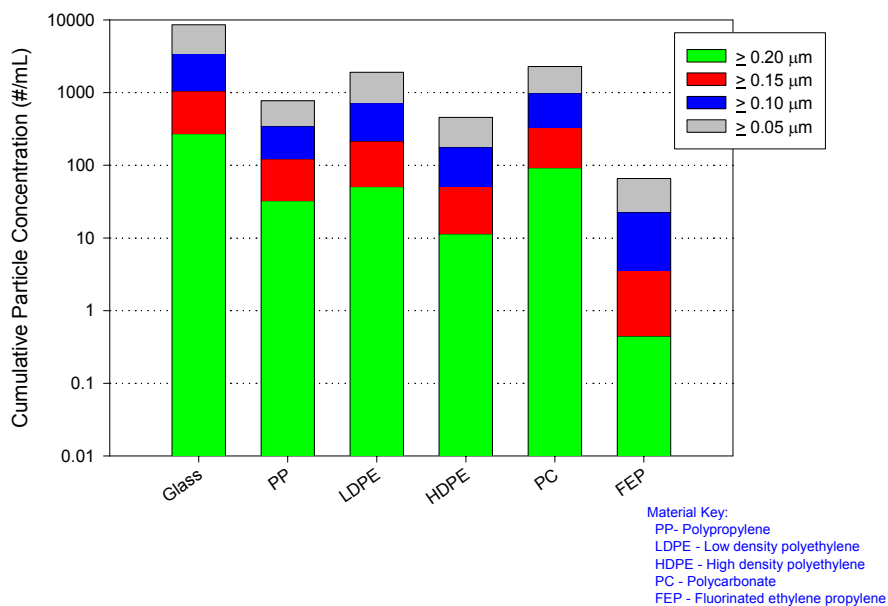

Figure 7. Particle shedding from various sample bottles after inverting 200 times

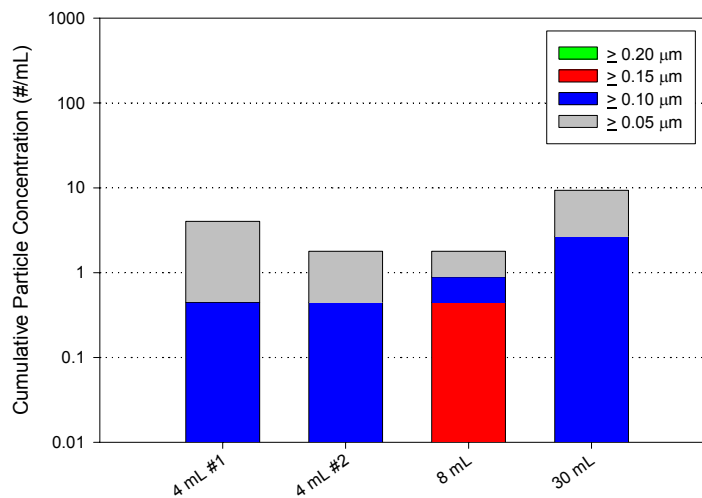

Figure 8. Effect of minimal headspace on particle shedding after inverting 200 times

When used with a suitable dilution system, 4mL or 8 mL particle-standard bottles, filled with PSL particles at a concentration of 4×10^7 per mL, will provide a sufficient number of PSL particles for a 40-minute calibration verification for OPCs with flow rates of 100 mL/min and 1000 mL/min; respectively.. The bottles are now “single-use” bottles.

The PSL Dilution System.

A precision dilution system is required to dilute the PSL concentration from 4×10^7 PSL particles per mL to an acceptable OPC-challenge concentration. The challenge concentration for any OPC should be 80% of the maximum allowable concentration before particle coincidence occurs (a number provided by all OPC manufactures).

Figure 9 illustrates a suitable dilution system. A precision, peristaltic, metering pump injects a know concentration of PSL particles into a known flow rate of UPW. A pressure regulator regulates the flow of incoming UPW to approximately 15 psi, because peristaltic pumps can only tolerate a low back pressure. The concentrated PSL and diluting UPW are mixed in a static mixing chamber. The dilution system contains an adjustable dilution flow meter to provide the desired dilution ratio, and optional, additional flow meters to ensure the correct flow through the OPC. The dilution system accommodates OPC flow rates from 10 mL/min up to 1000 mL/min.

A Calibration Verification example

Figure 10 shows the results of challenging a PMS HSLIS M50 with 60, 70, 80, and 100 nm PSL particles. The maximum recommended challenge concentration for the M50 is 10,000 particles per mL. The PSL concentration (4×10^7) was therefore injected at a flow rate of 0.1 mL/min, the dilution flow rate was set to 400 mL/min, and the M50 flow rate was set for 100 mL/min. These settings generate an OPC challenge concentration of 8,000 PSL particles per mL. At an injection rate of 0.1 mL/min, the single-use 4 mL particle standard bottle provides approximately 40 minutes of calibration time. Figure 10 clearly shows the increased counting efficiency as the challenge particle size increases.

Figure 11 slows the counting efficiency of the four PSL challenges (60, 70, 80, and 100 nm) superimposed upon the counting efficiency curve provided by the OPC manufacture (3). There is excellent agreement between the expected counting efficiency and the four challenge PSL sizes.

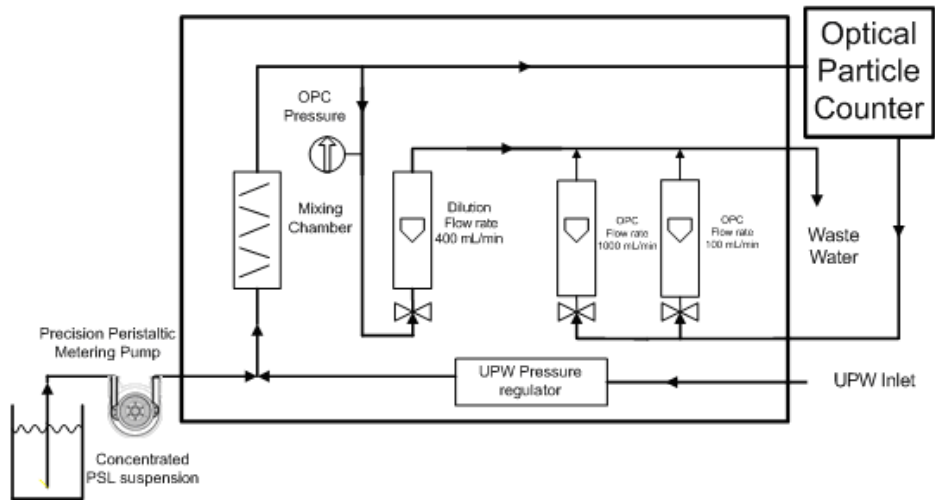

Figure 9. PSL Dilution System

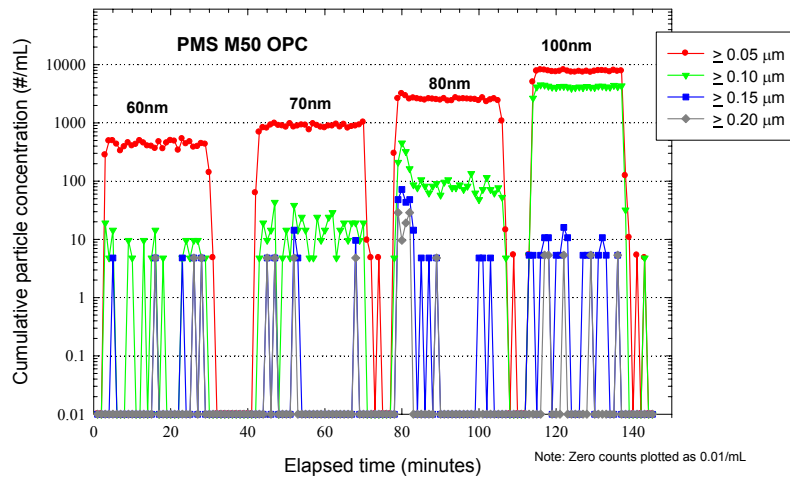

Figure 10. PMS HSLIS M50 OPC Challenged with 60, 70, 80, and 100nm PSL

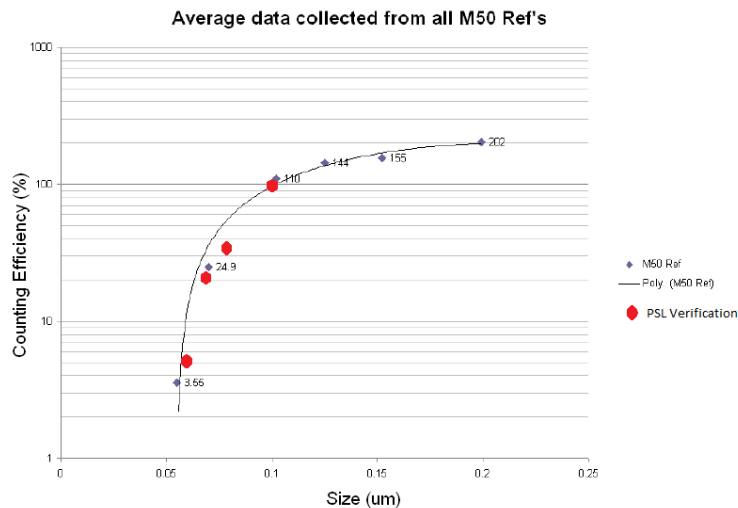

Figure 11. Counting efficiency of 60, 70, 80, and 100 nm PSL challenges superimposed upon the counting efficiency provided by the OPC manufacturer.

Uncertainty analysis

An uncertainty analysis was performed on both the particle standard and the dilution system using NIST guidelines (4). Currently, all PSL standards provided are NIST traceable for size only. The results of the uncertainty analysis are presented in Table 1. All the relative standard uncertainty data were determined statistically (Type A) except for ID 5. ID 5 is a calculated value based upon the change in water density caused by temperature variation (Type B). The combined uncertainty was determined with a root-sum-of squares (RSS) methodology using a coverage factor k of 2 (~ 95% confidence).

The largest contributor to uncertainty for the particle standard is the determination of the inspection volume used to calibrate the UFA/SMPS. The largest overall uncertainty contributor is the flowrate variability of the standard injection. Total combined uncertainty for the standard and dilution system was 0.0423 (4.23%).

ID	Uncertainty Component - Particle Standard	Relative Standard Uncertainty	ID	Uncertainty Component - Dilution System	Relative Standard Uncertainty
1	Calibration standard, % solids uncertainty	0.0006	8	Injection flowrate uncertainty	0.0251
2	Dilution and calibration variability	0.0129	9	Dilution system flowrate uncertainty	0.0025
3	Uncertainty of mass before dilution	0.0000		Combined Dilution Uncertainty ($k = 2$):	0.0357
4	Uncertainty of volume of diluent	0.0092			
5	Diluent volume to mass uncertainty due to temperature	0.0012		Combined Total Uncertainty ($k = 2$):	0.0423
6	Sample mixing	0.0000			
7	Sample bottle (all sources)	0.0025			
	Combined Standard Uncertainty ($k = 2$):	0.0228			

Table 1. Uncertainty of particle concentration

Future Standards

As particle counting instruments capable of measuring <50nm become available, the ability to use PSL as a particle standard is questionable. Currently, as the nominal diameter of the PSL standard becomes smaller, the relative size variability (standard deviation) becomes much larger, to the point where PSL spheres may no longer be suitable as a calibration standard (see Figure 12). As a result, more uniform PSL particles, or new particles with a more uniform size distribution, may be required to calibrate instruments measuring down to the 30 to 10 nm range. Examples of nanoparticles with attractive size distributions are presented in Figures 13 and 14. These, or other types of nanoparticles, may become beneficial as a particle standard in the future.

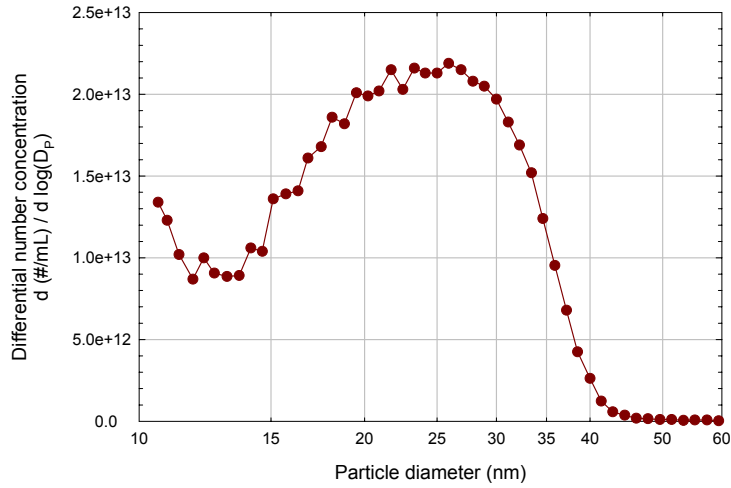

Figure 12: Nominal 30 nm PSL particle, showing a significant variation in particle size

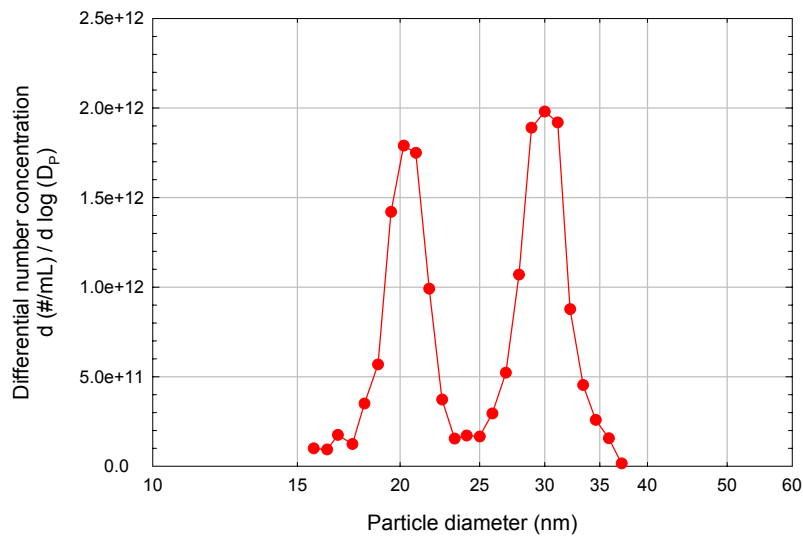

Figure 13: A mixture of 20 and 30 nm gold particles

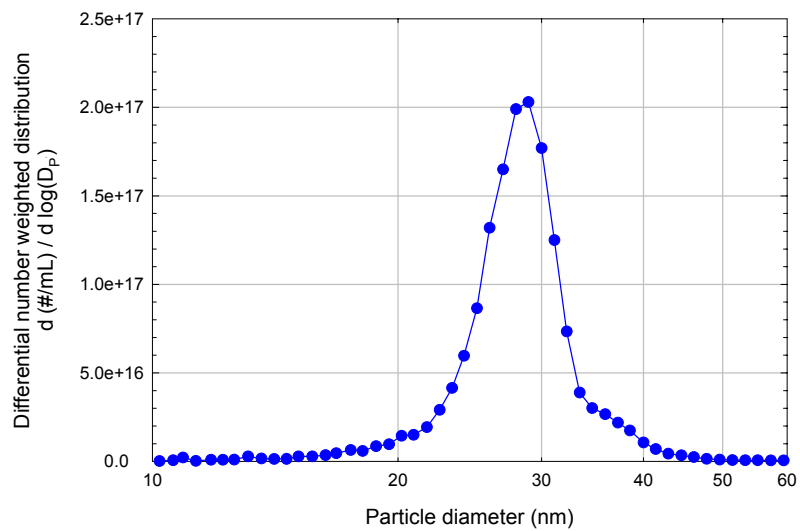

Figure 14: 28 nm colloidal silica particles

Summary and conclusion

The authors have developed a series of PSL calibration-verification standards to verify the calibration of Optical Particle Counters. These standards are not certified by any calibration authority (such as NIST or AIST) so they cannot be used as primary standards. However, when used with a dilution system, the standards can be used to test or check whether an existing OPC calibration is still valid, and therefore reduce the frequency of the OPC manufacturer's calibration. For the first time the new verification standards can also be used to independently compare the counting efficiency of 50nm OPCs from different manufacturers.

References:

- (1) Grant, D.C., Kelly, W and Carrieri, D., Comparison of Optical Particle Sensors used to Measure Particle Concentrations in High-purity Chemicals, Phase I - Sensor Comparison in Water: Proceedings of the 18th Annual Semiconductor Pure Water and Chemicals Conference, March 1999.
- (2) US Patent 7,188,644 Kelly, W and Chilcote, D., Apparatus and method for minimizing the penetration of particles in ultrapure liquids. Issued 13 March, 2007.
- (3) Beal, D., Liquid Optical Particle Counters: Calibration and Correlation Challenges, SEMICON West, July 2008, Standards Workshop.
- (4) Taylor, B.N. and Kuyatt, C.E., Guidelines for Evaluating and Expressing the Uncertainty of NIST Measurement Results, NIST Technical Note 1297, 1994.